

Typical NSL Retention and Database Use

Phone Records:

NSL toll billings records are typically uploaded into Telephone Applications (TA) after receipt. A subset of Counterterrorism information is uploaded into (S) [redacted] for analysis. The information can also be uploaded from TA to other applications (such as [redacted] for analysis. NSL-derived toll billings records are also placed in Automated Case Support (ACS) with case information. ACS information is uploaded into Investigative Data Warehouse (IDW).

(S)
b1
b2

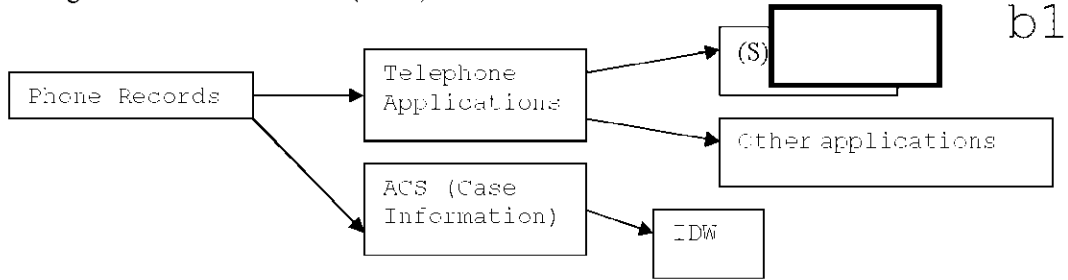

b1

Email Records:

NSL electronic transactional information is typically entered into ACS upon receipt. ACS information is uploaded into Investigative Data Warehouse (IDW). Counterterrorism email information can be manually entered into (S) [redacted] Email information may in some cases be entered into spreadsheets and other databases for analysis.

(S)

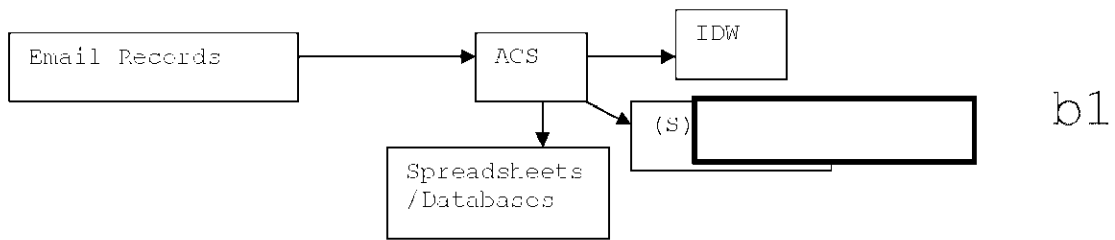

b1

b1

Financial and Credit Information:

Financial and credit information is typically entered into ACS upon receipt. ACS information is uploaded into Investigative Data Warehouse (IDW). Financial and credit information may in some cases be entered into spreadsheets and other databases for analysis.

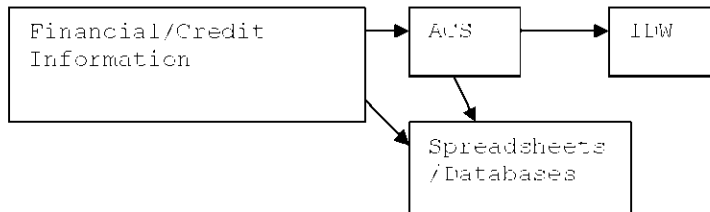

1073946

~~SECRET~~

Effect of Closing a Case in ACS:

A case is closed when all investigative and legal activity has ceased. It is still as accessible as it was while it was opened. Documentation is placed in ACS to indicate that the case is closed. Action leads cannot be set from closed cases. Records are maintained according to the records disposition schedule for the particular file classification or the General Records Schedule. Criminal cases are kept for a minimum of 20 years and intelligence for 30 years before disposition.

~~SECRET~~ NSL VIO-17490

FEDERAL BUREAU OF INVESTIGATION

Precedence: IMMEDIATE

Date: 03/02/2007

To: All Field Offices

Attn: ADIC
SAC
CDC
FCI Supervisors
Attn: AD Berezney
DADs
Section Chiefs

Counterintelligence

From: National Security Branch

Contact: [Redacted] 202-324-[Redacted]

1073946

Approved By: Hulon Willie T

ALL INFORMATION CONTAINED
HEREIN IS UNCLASSIFIED
DATE 06-08-2007 BY 65179/DMH/KSR/RW

Drafted By: [Redacted] bls

Case ID #: 319X-HQ-A1487720-OGC

Title: GUIDANCE ON USE OF FAIR CREDIT
REPORTING ACT NSLS IN COUNTERINTELLIGENCE INVESTIGATIONS;
REVIEW OF FAIR CREDIT REPORTING ACT
NSLS ISSUED IN CY 2006 IN
COUNTERINTELLIGENCE INVESTIGATIONS

Synopsis: Provides guidance on the statutory restrictions controlling the issuance of national security letters (NSLs) to obtain full credit reports in counterintelligence investigations. Directs Counterintelligence Division (CD) and Field Office personnel involved in counterintelligence investigations to review NSLs issued pursuant to the Fair Credit Reporting Act (FCRA) to determine if full credit reports were improperly requested or received; and to report the results of such review.

Details: The FCRA provides for the protection of personal information assembled by credit reporting agencies. Two provisions of the FCRA, 1681u and 1681v, authorize the FBI to obtain information from credit reporting agencies in the context of national security investigations. Section 1681u(a) authorizes the FBI to obtain the identity of all financial institutions at which the consumer maintains or has maintained an account; 1681u(b) authorizes the FBI to obtain consumer identifying information, that is, the name, address, former addresses, place of employment, and former places of employment of the consumer. This information can be obtained when "sought for the conduct of an authorized investigation to protect against international terrorism or clandestine intelligence activities."

b6
b7C
b2

To: All Field Offices From: National Security Branch
Re: 319X-HQ-A1487720-OGC, 03/02/2007

Section 1681v of the FCRA was added by the 2001 USA PATRIOT Act. This section authorizes the FBI to obtain full consumer credit reports. However, NSLs can be issued pursuant to this section only to conduct investigations related to international terrorism. **The FBI may not use an NSL to obtain a full credit report in a counterintelligence investigations absent an international terrorism nexus.**

Nonetheless, it has come to the attention of the National Security Branch (NSB) that in some instances full credit reports for counterintelligence investigations unrelated to international terrorism have been obtained or requested under a FCRA Section 1681v NSL. The request or receipt of such information in this context violates FCRA statutory requirements.

Therefore, receiving offices are directed to review FCRA NSLs issued in CY 2006 in the context of a counterintelligence investigations unrelated to international terrorism in order to determine if any such NSLs requested full credit reports or resulted in the receipt of full credit reports. If such reports were requested or obtained, the incident should be reported to the National Security Law Branch (NSLB) as a potential Intelligence Oversight Board (IOB) violation (regardless of who was at fault). NSLB will determine whether in fact the incident should be reported to the IOB.

Further, if such information has been obtained improperly, the information should be sequestered with the Chief Division Counsel pending the issuance of the IOB opinion by NSLB. The EC that is issued by NSLB will provide guidance as to how the information is to be permanently handled. Most likely, NSLB will suggest that the information be returned to the credit reporting agency.

AN EC TO NSB AND NSLB DOCUMENTING THE RESULTS OF THIS SEARCH IS MANDATORY, EVEN IF THE SEARCH IS NEGATIVE. RESULTS OF THIS SEARCH SHOULD BE SENT WITHIN 30 DAYS FROM THE DATE OF THIS EC.

You may direct any questions concerning this matter to NSLB attorney [redacted] at 202-324-[redacted]

b6
b7C
b2

To: All Field Offices From: National Security Branch
Re: 319X-HQ-A1487720-OGC, 03/02/2007

LEAD(s) :

Set Lead 1: (Action)

ALL RECEIVING OFFICES

Receiving offices are directed to review FCRA NSLs issued in CY 2006 in the context of a counterintelligence investigation and determine if any such NSLs requested full credit reports or resulted in the receipt of full credit reports. If such reports were requested or obtained, the incident should be reported to NSLB as a potential IOB violation. Further, the results of such review must be reported by EC to NSB and NSLB within 30 days of the date of this EC.

◆◆

b6
b7C

From: [redacted] (OGC) (FBI)
Sent: Friday, March 02, 2007 5:30 PM
To: [redacted] (OGC) (FBI); [redacted] (OGC)
[redacted] (FBI); [redacted] (OGC) (FBI)
Cc: [redacted] (OGC) (FBI)
Subject: Comprehensive EC and Issue List
~~**SECRET**~~
~~**RECORD xxxx**~~

All,
In case it comes up while I'm out, attached is the latest version of the Uber EC and the preliminary NSL issue list. The EC definitely needs to be tightened up and certain issues will need to be inserted once the shorter ECs go out. Hopefully that won't need to happen until I come back.



Comprehensive NSL
EC.wpd (65 K...



National Security
Letter Cheat...

~~**DERIVED FROM: G-3 FBI Classification Guide G-3, dated 1/97, Foreign CounterIntelligence Investigations**~~
~~**DECLASSIFICATION EXEMPTION 1**~~
~~**SECRET**~~

DECLASSIFIED BY 65179/DMH/KSR/RD
ON 06-08-2007

1073946

From: [redacted] (OGC) (FBI)
Sent: Tuesday, March 20, 2007 9:50 AM
To: [redacted] (OGC) (FBI); [redacted] (OGC)
(FBI); [redacted] (OGC) (FBI); [redacted] (OGC)
(FBI); [redacted] (OGC) (FBI)
Subject: Document for DOJ/DNI NSL Retention Working Group

b6
b7C

~~**SECRET
RECORD xxxx**~~

All,
Pat Kelley and I are in a DOJ/DNI working group examining the FBI's retention of NSL-derived information. The group has asked that we provide a chart outlining how NSL-derived information is used and where it is stored. They also asked us for a description of what effect closing a case has on the accessibility of the case. Please take a look at the attached and let me know if you have any comments. If you would like to run this by operators, feel free. The group is composed of DOJ/DNI and other intelligence agencies, and is cleared at least to the Secret level.

If you have any comments, please get them to me by 2pm tomorrow.

Thanks

[redacted]

b6
b7C



Retention
Paper.doc (42 KB)

~~**DERIVED FROM: G-3 FBI Classification Guide G-3, dated 1/97, Foreign CounterIntelligence
Investigations
DECLASSIFICATION EXEMPTION 1
SECRET**~~

DECLASSIFIED BY 65179/DMH/KSR/RM
ON 06-08-2007

NSL VIO-17509

From: [redacted] (OGC) (FBI)
Sent: Monday, March 05, 2007 4:21 PM
To: [redacted] (OGC) (FBI)
Subject: FW: Telephone EC and NSL

b6
b7C

Importance: High

~~**SECRET//NOFORN**
RECORD xxxx~~

At the bottom is the banner we added on March 9 to assure that everyone knew the changes were effective immediately

-----Original Message-----

From: [redacted] (OGC) (FBI)
Sent: Wednesday, March 15, 2006 9:33 AM
To: [redacted] (OGC) (FBI)
Subject: Telephone EC and NSL
Importance: High

DECLASSIFIED BY: 65179/DMH/KSR/RW
ON: 06-08-2007

~~**SECRET//NOFORN**
RECORD xxxx~~

1073946

[redacted]
Assistant General Counsel
National Security Law Policy and Training Unit
National Security Law Branch
Office of the General Counsel, FBI, JEH, Room 7947

Unclassified email: [redacted] gov
[redacted] gov
[redacted] gov

b6
b7C
b2

This is a Privileged Attorney-Client/Attorney Work Product Communication

-----Original Message-----

From: [redacted] (OGC) (FBI)
Sent: Thursday, March 09, 2006 3:20 PM
To: [redacted] (OGC) (FBI); [redacted] (TTOD)(CON)
Cc: [redacted] (OGC) (FBI); [redacted] (OGC) (FBI); [redacted] (OGC) (FBI)
Subject: RE: URGENT OGC NSLB Revisions - New EC and NSL ponies and Banner for posting on OGC website
Importance: High

~~**SECRET//NOFORN**
RECORD xxxx~~

b6
b7C

[redacted] you have it correct.

Attached are the two missing documents for links 1 and 2 (Telephone Subscriber EC and Telephone Subscriber NSL). I have also attached the EC just approved by the Director that delegates signature authorities for NSLs. There is no existing link for this document. Please add it to the other 16

NSL VIO-17515



NSL delegation EC approved by ...



subscriber EC.wpd



(1)subscriber NSL.wpd

Finally, please edit the banner for this folder to delete the last sentence: "NOTE: NEW NSLs SHOULD NOT BE APPROVED UNTIL THE DIRECTOR HAS DELEGATED THE SIGNING AUTHORITY." -- as that has now occurred in the document you are posting.

Thanks to you both for your WONDERFUL HELP on this on such short notice.

[Redacted]

[Redacted]

Assistant General Counsel
National Security Law Policy and Training Unit
National Security Law Branch
Office of the General Counsel, FBI, JEH, Room 7947

b2
b6
b7C

[Redacted] gov
Unclassified email [Redacted] gov
[Redacted] gov
[Redacted] gov

This is a Privileged Attorney-Client/Attorney Work Product Communication

-----Original Message-----

From: [Redacted] (OGC) (FBI)
Sent: Thursday, March 09, 2006 2:38 PM
To: [Redacted] (ITOD)(CON)
Cc: [Redacted] (OGC) (FBI)
Subject: FW: URGENT OGC NSLB Revisions - New EC and NSL ponies and Banner for posting on OGC website
Importance: High

b6
b7C

~~**SECRET//NOFORN**~~
~~**RECORD xxxx**~~

b6
b7C

[Redacted]

Thank you. This is my best interpretation of what NSLB needs.

First, please disable the links for the model EC and NSLs listed about three-fourths of the way down the National Security Letters webpage [Redacted] DO NOT DELETE the files on your end as I don't know if NSLB will need them in the future.

b2

At the top and bottom of the NSL webpage please post the following notation - in bold/caps, etc.

The President will be signing the USA PATRIOT Improvement and Reauthorization Act at approximately 3 p.m.(EST) today, March 9, 2006. At that point, all NSLs

must comply with the new law. FBI OGC NSLB has posted new NSL forms on this website. The new law makes adjustments to the Director's delegation authority. Under the new law, FBI HQ Section Chiefs do not have the authority to approve NSLs. NOTE: NEW NSLs SHOULD NOT BE APPROVED UNTIL THE DIRECTOR HAS DELEGATED THE SIGNING AUTHORITY.

After that notation at the top of the page, please insert the following and link to the documents referenced below (feel free to modify the filenames as you deem appropriate in order to differentiate them from the existing filenames). These documents should all stay in the Word Perfect format as they are ponies/samples to be used by Field Office personnel.

Model ECs and NSLs (as at March 9, 2006)

1. Telephone Subscriber EC [link to follow by separate e-mail when received from NSLB]
2. Telephone Subscriber NSL [link to follow by separate e-mail when received from NSLB]
3. Toll Record EC [link to toll record EC 2006.03.09.wpd]
4. Toll Record NSL [link to toll record NSL 2006.03.09.wpd]
5. E-Mail Subscriber EC [link to email EC 2006.03.09.wpd]
6. E-Mail Subscriber NSL [link to email NSL 2006.03.09.wpd]
7. Transactional Record EC [link to transactional record EC 2006.03.09.wpd]
8. Transactional Record NSL [link to transactional record NSL 2006.03.09.wpd]
9. RFPA EC [link to RFPA EC 2006.03.09.wpd]
10. RFPA NSL [link to RFPA NSL 2006.03.09.wpd]
11. 1681u(a) EC [link to 1681u(a) EC 2006.03.09.wpd]
12. 1681u(a) NSL [link to 1681u(a) NSL 2006.03.09.wpd]
13. 1681u(b) EC [link to 1681u(b) EC 2006.03.09.wpd]
14. 1681u(b) NSL [link to 1681u(b) NSL 2006.03.09.wpd]
15. 1681v EC [link to 1681v EC 2006.03.09.wpd]
16. 1681v NSL [link to 1681v NSL 2006.03.09.wpd]

A thousand Thank You's for your help with this. Please call if any of this is confusing.

[redacted] OGC
[redacted]

b2
b6
b7C

-----Original Message-----

From: [redacted] (OGC) (FBI)
Sent: Thursday, March 09, 2006 1:03 PM
To: [redacted] (OGC) (FBI)
Cc: [redacted] (OGC) (FBI); [redacted] (OGC) (FBI); [redacted] (OGC) (FBI); [redacted] (OGC) (FBI); [redacted] (OGC) (FBI); [redacted] (OGC) (FBI); THOMAS, JULIE F. (OGC) (FBI); [redacted] (OGC) (FBI); [redacted] (OGC) (FBI); [redacted] (OGC) (FBI); [redacted] (OGC) (FBI); [redacted] (OGC) (FBI)
Subject: New EC and NSL ponies and Banner for posting on OGC website

b6
b7C

Importance: High

~~SECRET//NOFORN
RECORD xxxx~~

H [redacted]

b6
b7C

We have 14 documents that need to be posted to our website this afternoon if at all possible. The President is signing the PATRIOT Act renewal at about 3:00 pm today and it changes the rules regarding NATIONAL SECURITY LETTERS. There are seven different types of NSLs. The attached documents are 7 ECs and the corresponding 7 NSL forms.

Please post them under the Banner below in the email from [redacted]

<< File: transactional record NSL 2006.03.09.wpd >> << File: 1681u(a) NSL 2006.03.09.wpd >> << File: 1681u(b) EC 2006.03.09.wpd >> << File: 1681u(b) NSL 2006.03.09.wpd >> << File: 1681v EC 2006.03.09.wpd >> << File: 1681v NSL 2006.03.09.wpd >> << File: email EC 2006.03.09.wpd >> << File: email NSL 2006.03.09.wpd >> << File: RFPA ec 2006.03.09.wpd >> << File: RFPA NSL 2006.03.09.wpd >> << File: toll record EC 2006.03.09.wpd >> << File: toll record NSL 2006.03.09.wpd >> << File: transactional record EC 2006.03.09.wpd >> << File: 1681u(a) EC 2006.03.09.wpd >>

Please let us know when they are available on the website.

Many thanks

[redacted]
[redacted]

Assistant General Counsel
National Security Law Policy and Training Unit
National Security Law Branch
Office of the General Counsel, FBI, JEH, Room 7947

b2
b6
b7C

Unclassified email: [redacted] gov
[redacted] gov
[redacted] gov

This is a Privileged Attorney-Client/Attorney Work Product Communication

-----Original Message-----

From: [redacted] (OGC) (FBI)
Sent: Thursday, March 09, 2006 12:50 PM
To: [redacted] (OGC) (FBI)
Cc: [redacted] (OGC) (FBI); [redacted] (OGC) (FBI); [redacted] (OGC) (FBI); [redacted] (OGC) (FBI)
Subject: Banner for webpage re new NSLs.

b6
b7C

~~UNCLASSIFIED
NON-RECORD~~

[redacted]

b6
b7C

The new NSL forms should be posted with this banner prominently displayed at the top and bottom of the page.

The President will be signing the USA PATRIOT Improvement and Reauthorization Act at approximately 3 p.m.(EST) today, March 9, 2006. At that point, all NSLs must comply with the new law. FBI OGC NSLB has posted new NSL forms on this website. The new law makes adjustments to the Director's delegation authority. Under the new law, FBI HQ Section Chiefs do not have the authority to approve NSLs. NOTE: NEW NSLs SHOULD NOT BE APPROVED UNTIL THE DIRECTOR HAS DELEGATED THE SIGNING AUTHORITY.

[Redacted]
Assistant General Counsel
National Security Law Policy and Training Unit
FBI HQ Room 7975
STU III: [Redacted]
Unclassified Fax: [Redacted]
Secure Fax: [Redacted]

b2
b6
b7C

Privileged Attorney-Client/Attorney Work Product Communication

UNCLASSIFIED

DERIVED FROM: Multiple Sources
DECLASSIFY ON: 20160309
SECRET//NOFORN

DERIVED FROM: Multiple Sources
DECLASSIFY ON: 20160309
SECRET//NOFORN

DERIVED FROM: Multiple Sources
DECLASSIFY ON: 20160309
SECRET//NOFORN

DERIVED FROM: Multiple Sources

NSL VIO-17519

~~DECLASSIFY ON: 20160309
SECRET//NOFORN~~

~~DERIVED FROM: Multiple Sources
DECLASSIFY ON: 20160309
SECRET//NOFORN~~

From: [redacted] (OGC) (FBI)
Sent: Monday, March 19, 2007 11:01 AM
To: [redacted] (OGC) (FBI); [redacted] (OGC)(FBI);
[redacted] (OGC) (FBI); [redacted] (OGC) (FBI)
Subject: Information for NSL Retention Group

b6
b7C

Subject:
SECRET
RECORD xxxx

All,
Could you please take a quick look at the attached? The DOJ/DNI NSL Retention Working group has asked for a description and chart of NSL analysis/retention and a description of the effect of closing a case in ACS. Let me know if anything is wrong or missing. I will send this to UCs later today but wanted you to have a look first.

Thanks,
[redacted]

b6
b7C



Retention
Paper.doc (41 KB)

~~**DERIVED FROM: G-3 FBI Classification Guide G-3, dated 1/97, Foreign CounterIntelligence Investigations**
DECLASSIFICATION EXEMPTION 1
SECRET~~

DECLASSIFIED BY 65179/DMH/KSR/RW
ON 06-08-2007

NSL VIO-17521

From: [redacted] (OGC) (FBI)
Sent: Friday, March 02, 2007 5:41 PM
To: [redacted] (OGC) (FBI); [redacted] (OGC) (FBI); [redacted] (FBI); [redacted] (OGC) (FBI)
Cc: [redacted] (OGC) (FBI)
Subject: Latest Version of ECs



b6
b7C

SENSITIVE BUT UNCLASSIFIED
NON-RECORD

All,
Attached are the latest versions of the other ECs I've been working on, in case action is required while I'm out. You probably already have these, but I wanted to make sure. They are also in the NSLPTU Folder [redacted] EC Drafts. If you need to contact me, I will have my cell (703-635-[redacted])

Thanks,
[redacted]

b6
b7C
b2

-  CD - Full Credit EC.wpd (15 KB...)
-  NSL Retention EC (with edits)...
-  NSL C of S.wpd (7 KB)

SENSITIVE BUT UNCLASSIFIED

ALL INFORMATION CONTAINED
HEREIN IS UNCLASSIFIED
DATE 06-08-2007 BY 65179/DMH/KSR/RW

NSL VIO-17522

CERTIFICATE OF SERVICE OF A NATIONAL SECURITY LETTER

Personal Service

Date, Time, and Place of Service _____
NSL Custodian of Record (including business name) _____
NSL Recipient (if different from above) _____
Served by _____
Serving Office _____
Originating Office (if different) _____
Type of NSL Request (cite statute used) _____

Delivery Service (attach return receipt)

Date, Time, and Place of Pickup _____
Date, Time, and Place of Delivery _____
NSL Custodian of Record (including business name) _____
Name and Type of Delivery Service (overnight, two day, etc) _____
Served by _____
Serving Office _____
Type of NSL Request (cite statute used) _____

Fax (attach fax cover letter and return receipt)

Date, Time, and Place of Fax _____
Recipient of Fax _____
NSL Custodian of Record (including business name) _____
Type of NSL Request (cite statute used) _____
Serving Office _____

ALL INFORMATION CONTAINED
HEREIN IS UNCLASSIFIED
DATE 06-08-2007 BY 65179/DMH/KSR/RG

DECLARATION OF SERVER

I declare under penalty of perjury under the laws of the United States of America that the foregoing information contained in the Certificate of Service of a National Security Letter is true and correct.

Executed on _____
Date

By: _____
Signature of Server

Inquiries Regarding Production May Be Directed to:

[Name], Special Agent
Federal Bureau of Investigation
[Name of] Field Office
[Telephone number]

From: [redacted] (OGC) (FBI)
Sent: Monday, March 12, 2007 3:05 PM
To: [redacted] (INSD) (FBI)
Cc: THOMAS, JULIE F. (OGC) (FBI); [redacted] (OGC) (FBI)
Subject: NSL Checklist for INSD

b6
b7C

SENSITIVE BUT UNCLASSIFIED
NON-RECORD

[redacted]

Attached is the checklist we discussed. As I said, it has not been approved by the General Counsel. I will go about putting together another checklist to meet your needs but any input on what you are looking for would be appreciated.

b6
b7C

Thanks

[redacted]



NSL REVIEW
HECKLIST.doc (74 K)

SENSITIVE BUT UNCLASSIFIED

ALL INFORMATION CONTAINED
HEREIN IS UNCLASSIFIED
DATE 06-08-2007 BY 65179/DMH/ESR/RW

NSL VIO-17526

Typical NSL Retention and Database Use

Phone Records:

(S)

(S) NSL toll billings records are typically uploaded into Telephone Applications (TA) after receipt. Most information in TA is uploaded into FBI [redacted] for analysis. TA is shared in two forms: a "raw" version that contains individual phone call events, and an "indexed" version that does not contain individual phone call events. Most indexed TA information is a dataset of IDW and FTTTF. The information can also be uploaded from TA to other applications (such as [redacted] for analysis. NSL-derived information is also placed in Automated Case Support (ACS) with case information. With the exception of designated restricted case files, most ACS information is available as a dataset in Investigative Data Warehouse (IDW).

b1
b2

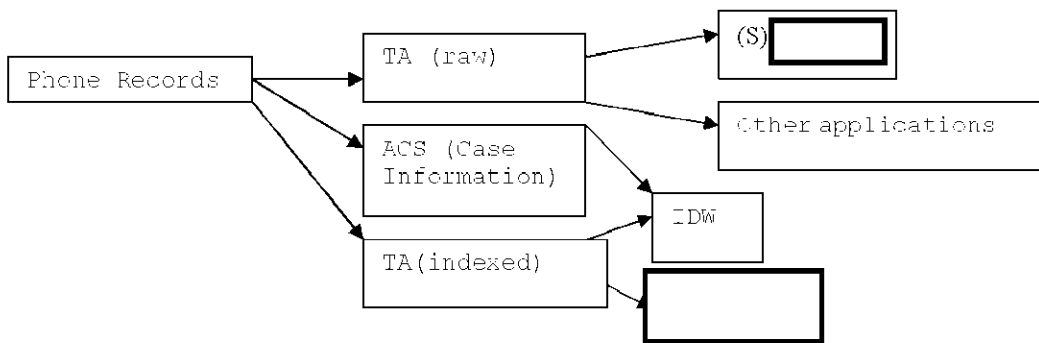

b1

Email Records:

(S)

(S) NSL electronic transactional information is typically entered into ACS upon receipt. With the exception of designated restricted case files, most ACS information is available as a dataset in IDW. Counterterrorism email information can be manually entered into FBI [redacted] Email information may in some cases be entered into spreadsheets and other databases for analysis.

b1

(S)

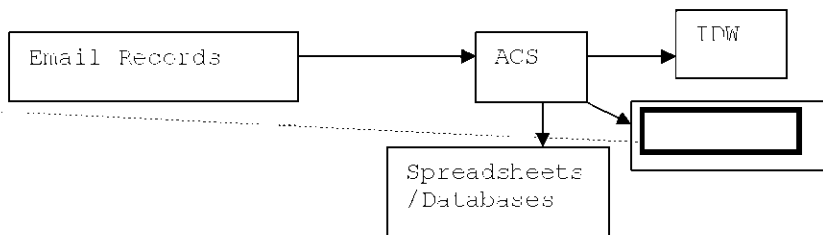

b1

Financial and Credit Information:

(U) Financial and credit information is typically entered into ACS upon receipt. ACS information is uploaded into Investigative Data Warehouse (IDW). Financial and credit information may in some cases be entered into spreadsheets and other databases for analysis.

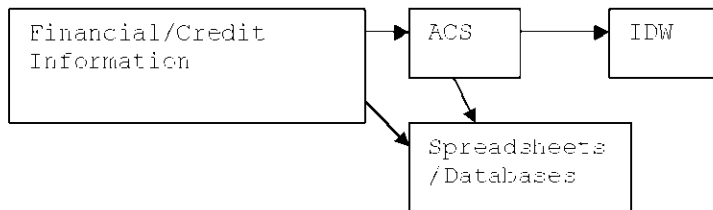

DATE: 06-15-2007
CLASSIFIED BY: 675179/DMH/KSR/RW
REASON: 1.4.(g)
DECLASSIFY ON: 06-15-2032

ALL INFORMATION CONTAINED
HEREIN IS UNCLASSIFIED EXCEPT
WHERE SHOWN OTHERWISE

~~SECRET~~

Effect of Closing a Case in ACS:

(U) A case is closed when all investigative and legal activity has ceased. The closed case is as accessible as it was while it was opened. Documentation is placed in ACS to indicate that the case is closed. Action leads cannot be set from closed cases. Records in ACS are maintained according to the records disposition schedule for the particular file classification or the General Records Schedule. Criminal cases are kept for a minimum of 20 years and intelligence for 30 years before disposition. Retention can be extended if one of various exceptions apply.

~~SECRET~~

NSL VIO-17535

